

# MAX4238/MAX4239

# Ultra-Low Offset/Drift, Low-Noise, Precision SOT23 Amplifiers

## General Description

The MAX4238/MAX4239 are low-noise, low-drift, ultra-high precision amplifiers that offer near-zero DC offset and drift through the use of patented autocorrelating zeroing techniques. This method constantly measures and compensates the input offset, eliminating drift over time and temperature and the effect of 1/f noise. Both devices feature rail-to-rail outputs, operate from a single 2.7V to 5.5V supply, and consume only 600µA. An active-low shutdown mode decreases supply current to 0.1µA.

The MAX4238 is unity-gain stable with a gain-bandwidth product of 1MHz, while the decompensated MAX4239 is stable with  $A_V \geq 10V/V$  and a GBWP of 6.5MHz. The MAX4238/MAX4239 are available in 8-pin narrow SO, 6-pin TDFN and SOT23 packages.

## Applications

- Thermocouples
- Strain Gauges
- Electronic Scales
- Medical Instrumentation
- Instrumentation Amplifiers

## Typical Application Circuit

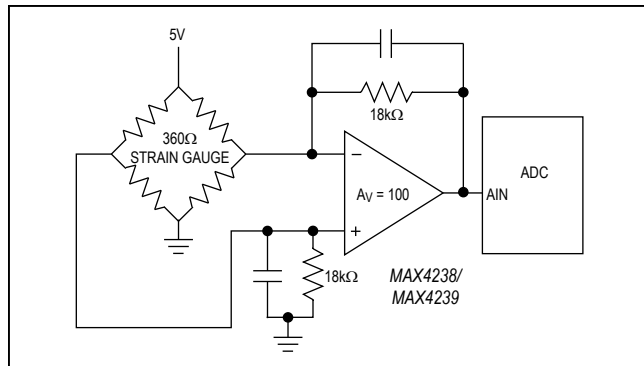

## Benefits and Features

- DC Performance Ideal for High-Precision Sensor Interface
  - Ultra-Low, 0.1µV Offset Voltage
    - 2.0µV (max) at +25°C
    - 2.5µV (max) at -40°C to +85°C
    - 3.5µV (max) at -40°C to +125°C
  - Low 10nV/°C Drift
  - Low Noise: 1.5µV<sub>P-P</sub> from DC to 10Hz
  - 150dB  $AV_{OL}$ , 140dB PSRR, 140dB CMRR
  - High Gain-Bandwidth Product
    - 1MHz (MAX4238)
    - 6.5MHz (MAX4239)
  - Ground-Sensing Input
  - Rail-to-Rail Output ( $R_L = 1k\Omega$ )
- Low Power Consumption Reduces System Power
  - Single 2.7V to 5.5V Supply Voltage Range
  - 600µA Supply Current
  - 0.1µA Shutdown Mode

Pin Configurations appear at end of data sheet.

## Ordering Information

| PART           | PIN-PACKAGE | TOP MARK |
|----------------|-------------|----------|
| MAX4238AUT-T   | 6 SOT23     | AAZZ     |
| MAX4238AUT/V+T | 6 SOT23     | —        |
| MAX4238ASA     | 8 SO        | —        |
| MAX4238ATT+T   | 6 TDFN-EP*  | +ANG     |
| MAX4239AUT-T   | 6 SOT23     | ABAA     |
| MAX4239AUT/V+T | 6 SOT23     | —        |
| MAX4239ASA     | 8 SO        | —        |
| MAX4239ATT+T   | 6 TDFN-EP*  | +ANH     |

**Note:** All devices are specified over the -40°C to +125°C operating temperature range.

+Denotes a lead(Pb)-free/RoHS-compliant package.

\*EP = Exposed paddle.

V denotes an automotive-qualified part.

## Selector Guide

| PART    | MINIMUM STABLE GAIN | GAIN BANDWIDTH (MHz) |
|---------|---------------------|----------------------|
| MAX4238 | 1V/V                | 1                    |
| MAX4239 | 10V/V               | 6.5                  |

**Absolute Maximum Ratings**

Power-Supply Voltage ( $V_{CC}$  to GND).....6V  
 All Other Pins .....( $V_{GND} - 0.3V$ ) to ( $V_{CC} + 0.3V$ )  
 Output Short-Circuit Duration  
 (OUT shorted to  $V_{CC}$  or GND) ..... Continuous  
 Continuous Power Dissipation ( $T_A = +70^\circ C$ )  
 6-Pin Plastic SOT23  
 (derate 9.1mW/ $^\circ C$  above  $+70^\circ C$ ) .....727mW  
 8-Pin Plastic SO (derate 5.88mW/ $^\circ C$  above  $+70^\circ C$ )...471mW  
 6-Pin TDFN-EP (derate 18.2mW above  $+70^\circ C$ ) .....1454mW

Operating Temperature Range.....  $-40^\circ C$  to  $+125^\circ C$   
 Junction Temperature .....  $+150^\circ C$   
 Storage Temperature Range .....  $-65^\circ C$  to  $+150^\circ C$   
 Lead Temperature (soldering, 10s) .....  $+300^\circ C$   
 Soldering Temperature (reflow)  
 Lead(Pb)-Free Packages .....  $+260^\circ C$   
 Packages Containing Lead.....  $+240^\circ C$

*Stresses beyond those listed under "Absolute Maximum Ratings" may cause permanent damage to the device. These are stress ratings only, and functional operation of the device at these or any other conditions beyond those indicated in the operational sections of the specifications is not implied. Exposure to absolute maximum rating conditions for extended periods may affect device reliability.*

**Electrical Characteristics**

( $2.7V \leq V_{CC} \leq 5.5V$ ,  $V_{CM} = V_{GND} = 0V$ ,  $V_{OUT} = V_{CC}/2$ ,  $R_L = 10k\Omega$  connected to  $V_{CC}/2$ ,  $\overline{SHDN} = V_{CC}$ ,  $T_A = +25^\circ C$ , unless otherwise noted.)

| PARAMETER                        | SYMBOL          | CONDITIONS                                                       | MIN               | TYP  | MAX            | UNITS           |
|----------------------------------|-----------------|------------------------------------------------------------------|-------------------|------|----------------|-----------------|
| Input Offset Voltage             | $V_{OS}$        | (Note 1)                                                         |                   | 0.1  | 2              | $\mu V$         |
| Long-Term Offset Drift           |                 |                                                                  |                   | 50   |                | nV/1000hr       |
| Input Bias Current               | $I_B$           | (Note 2)                                                         |                   | 1    |                | pA              |
| Input Offset Current             | $I_{OS}$        | (Note 2)                                                         |                   | 2    |                | pA              |
| Peak-to-Peak Input Noise Voltage | $e_{nP-P}$      | $R_S = 100\Omega$ , 0.01Hz to 10Hz                               |                   | 1.5  |                | $\mu V_{P-P}$   |
| Input Voltage-Noise Density      | $e_n$           | $f = 1kHz$                                                       |                   | 30   |                | NV/ $\sqrt{Hz}$ |
| Common-Mode Input Voltage Range  | $V_{CM}$        | Inferred from CMRR test                                          | $V_{GND} - 0.1$   |      | $V_{CC} - 1.3$ | V               |
| Common-Mode Rejection Ratio      | CMRR            | $-0.1V \leq V_{CM} \leq V_{CC} - 1.3V$ (Note 1)                  | 120               | 140  |                | dB              |
| Power-Supply Rejection Ratio     | PSRR            | $2.7V \leq V_{CC} \leq 5.5V$ (Note 1)                            | 120               | 140  |                | dB              |
| Large-Signal Voltage Gain        | $A_{VOL}$       | $0.05V \leq V_{OUT} \leq V_{CC} - 0.05V$<br>(Note 1)             | $R_L = 10k\Omega$ | 125  | 150            | dB              |
|                                  |                 | $0.1V \leq V_{OUT} \leq V_{CC} - 0.1V$<br>(Note 1)               | $R_L = 1k\Omega$  | 125  | 145            |                 |
| Output Voltage Swing             | $V_{OH}/V_{OL}$ | $R_L = 10k\Omega$                                                | $V_{CC} - V_{OH}$ | 4    | 10             | mV              |
|                                  |                 |                                                                  | $V_{OL}$          | 4    | 10             |                 |
|                                  |                 | $R_L = 1k\Omega$                                                 | $V_{CC} - V_{OH}$ | 35   | 50             |                 |
|                                  |                 |                                                                  | $V_{OL}$          | 35   | 50             |                 |
| Output Short-Circuit Current     |                 | To either supply                                                 | 40                |      | mA             |                 |
| Output Leakage Current           |                 | $0 \leq V_{OUT} \leq V_{CC}$ , $\overline{SHDN} = GND$ (Note 2)  | 0.01              | 1    | $\mu A$        |                 |
| Slew Rate                        |                 | $V_{CC} = 5V$ , $C_L = 100pF$ ,<br>$V_{OUT} = 2V$ step           | MAX4238           | 0.35 |                | V/ $\mu s$      |
|                                  |                 |                                                                  | MAX4239           | 1.6  |                |                 |
| Gain-Bandwidth Product           | GBWP            | $R_L = 10k\Omega$ , $C_L = 100pF$ ,<br>measured at $f = 100kHz$  | MAX4238           | 1    |                | MHz             |
|                                  |                 |                                                                  | MAX4239           | 6.5  |                |                 |
| Minimum Stable Closed-Loop Gain  |                 | $R_L = 10k\Omega$ , $C_L = 100pF$ ,<br>phase margin = $60^\circ$ | MAX4238           | 1    |                | V/V             |
|                                  |                 |                                                                  | MAX4239           | 10   |                |                 |

**Electrical Characteristics (continued)**

( $2.7V \leq V_{CC} \leq 5.5V$ ,  $V_{CM} = V_{GND} = 0V$ ,  $V_{OUT} = V_{CC}/2$ ,  $R_L = 10k\Omega$  connected to  $V_{CC}/2$ ,  $\overline{SHDN} = V_{CC}$ ,  $T_A = +25^\circ C$ , unless otherwise noted.)

| PARAMETER                | SYMBOL   | CONDITIONS                                                       | MIN              | TYP  | MAX | UNITS   |
|--------------------------|----------|------------------------------------------------------------------|------------------|------|-----|---------|
| Maximum Closed-Loop Gain |          | $R_L = 10k\Omega$ , $C_L = 100pF$ ,<br>phase margin = $60^\circ$ | MAX4238          | 1000 |     | V/V     |
|                          |          |                                                                  | MAX4239          | 6700 |     |         |
| Settling Time            |          | -1V step                                                         | 0.1% (10 bit)    | 0.5  |     | ms      |
|                          |          |                                                                  | 0.025% (12 bit)  | 1.0  |     |         |
|                          |          |                                                                  | 0.006% (14 bit)  | 1.7  |     |         |
|                          |          |                                                                  | 0.0015% (16 bit) | 2.3  |     |         |
| Overload Recovery Time   |          | $A_V = 10$<br>(Note 4)                                           | 0.1% (10 bit)    | 3.3  |     | ms      |
|                          |          |                                                                  | 0.025% (12 bit)  | 4.1  |     |         |
|                          |          |                                                                  | 0.006% (14 bit)  | 4.9  |     |         |
|                          |          |                                                                  | 0.0015% (16 bit) | 5.7  |     |         |
| Startup Time             |          | $A_V = 10$                                                       | 0.1% (10 bit)    | 1.8  |     | ms      |
|                          |          |                                                                  | 0.025% (12 bit)  | 2.6  |     |         |
|                          |          |                                                                  | 0.006% (14 bit)  | 3.4  |     |         |
|                          |          |                                                                  | 0.0015% (16 bit) | 4.3  |     |         |
| Supply Voltage Range     | $V_{CC}$ | Inferred by PSRR test                                            | 2.7              |      | 5.5 | V       |
| Supply Current           | $I_{CC}$ | SHDN = $V_{CC}$ , no load, $V_{CC} = 5.5V$                       |                  | 600  | 850 | $\mu A$ |
|                          |          | SHDN = GND, $V_{CC} = 5.5V$                                      |                  | 0.1  | 1   |         |
| Shutdown Logic-High      | $V_{IH}$ |                                                                  | 2.2              |      |     | V       |
| Shutdown Logic-Low       | $V_{IL}$ |                                                                  |                  |      | 0.8 | V       |
| Shutdown Input Current   |          | $0V \leq V_{SHDN} \leq V_{CC}$                                   |                  | 0.1  | 1   | $\mu A$ |

## Electrical Characteristics

( $2.7V \leq V_{CC} \leq 5.5V$ ,  $V_{CM} = GND = 0V$ ,  $V_{OUT} = V_{CC}/2$ ,  $R_L = 10k\Omega$  connected to  $V_{CC}/2$ ,  $\overline{SHDN} = V_{CC}$ ,  $T_A = -40^\circ C$  to  $+125^\circ C$ , unless otherwise noted.) (Note 5)

| PARAMETER                       | SYMBOL          | CONDITIONS                                                             |                                                                                   | MIN              | TYP | MAX            | UNITS         |
|---------------------------------|-----------------|------------------------------------------------------------------------|-----------------------------------------------------------------------------------|------------------|-----|----------------|---------------|
| Input Offset Voltage            | $V_{OS}$        | (Note 1)                                                               | $T_A = -40^\circ C$ to $+85^\circ C$                                              |                  |     | 2.5            | $\mu V$       |
|                                 |                 |                                                                        | $T_A = -40^\circ C$ to $+125^\circ C$                                             |                  |     | 3.5            |               |
| Input Offset Drift              | $TCV_{OS}$      | (Note 1)                                                               |                                                                                   |                  | 10  |                | $nV/^\circ C$ |
| Common-Mode Input Voltage Range | $V_{CM}$        | Inferred from CMRR test                                                |                                                                                   | $V_{GND} - 0.05$ |     | $V_{CC} - 1.4$ | V             |
| Common-Mode Rejection Ratio     | CMRR            | $V_{GND} - 0.05V \leq V_{CM} \leq V_{CC} - 1.4V$ (Note 1)              | $T_A = -40^\circ C$ to $+85^\circ C$                                              | 115              |     |                | dB            |
|                                 |                 |                                                                        | $T_A = -40^\circ C$ to $+125^\circ C$                                             | 90               |     |                |               |
| Power-Supply Rejection Ratio    | PSRR            | $2.7V \leq V_{CC} \leq 5.5V$ (Note 1)                                  |                                                                                   | 120              |     |                | dB            |
| Large-Signal Voltage Gain       | $A_{VOL}$       | $R_L = 10k\Omega$ ,<br>$0.1V \leq V_{OUT} \leq V_{CC} - 0.1V$ (Note 1) | $T_A = -40^\circ C$ to $+85^\circ C$                                              | 125              |     |                | dB            |
|                                 |                 |                                                                        | $T_A = -40^\circ C$ to $+125^\circ C$                                             | 95               |     |                |               |
|                                 |                 | $R_L = 1k\Omega$ (Note 1)                                              | $0.1V \leq V_{OUT} \leq V_{CC} - 0.1V$ ,<br>$T_A = -40^\circ C$ to $+85^\circ C$  | 120              |     |                | dB            |
|                                 |                 |                                                                        | $0.2V \leq V_{OUT} \leq V_{CC} - 0.2V$ ,<br>$T_A = -40^\circ C$ to $+125^\circ C$ | 80               |     |                |               |
| Output Voltage Swing            | $V_{OH}/V_{OL}$ | $R_L = 10k\Omega$                                                      | $V_{CC} - V_{OH}$                                                                 |                  |     | 20             | mV            |
|                                 |                 |                                                                        | $V_{OL}$                                                                          |                  |     | 20             |               |
|                                 |                 | $R_L = 1k\Omega$                                                       | $V_{CC} - V_{OH}$                                                                 |                  |     | 100            |               |
|                                 |                 |                                                                        | $V_{OL}$                                                                          |                  |     | 100            |               |
| Output Leakage Current          |                 | $0V \leq V_{OUT} \leq V_{CC}$ , $\overline{SHDN} = GND$ (Note 3)       |                                                                                   |                  |     | 2              | $\mu A$       |
| Supply Voltage Range            | $V_{CC}$        | Inferred by PSRR test                                                  |                                                                                   | 2.7              |     | 5.5            | V             |
| Supply Current                  | $I_{CC}$        | $\overline{SHDN} = V_{CC}$ , no load, $V_{CC} = 5.5V$                  |                                                                                   |                  |     | 900            | $\mu A$       |
|                                 |                 | $\overline{SHDN} = GND$ , $V_{CC} = 5.5V$                              |                                                                                   |                  |     | 2              |               |
| Shutdown Logic-High             | $V_{IH}$        |                                                                        |                                                                                   | 2.2              |     |                | V             |
| Shutdown Logic-Low              | $V_{IL}$        |                                                                        |                                                                                   |                  |     | 0.7            | V             |
| Shutdown Input Current          |                 | $0V \leq V_{\overline{SHDN}} \leq V_{CC}$                              |                                                                                   |                  |     | 2              | $\mu A$       |

**Note 1:** Guaranteed by design. Thermocouple and leakage effects preclude measurement of this parameter during production testing. Devices are screened during production testing to eliminate defective units.

**Note 2:**  $IN+$  and  $IN-$  are gates to CMOS transistors with typical input bias current of 1pA. CMOS leakage is so small that it is impractical to test and guarantee in production. Devices are screened during production testing to eliminate defective units.

**Note 3:** Leakage does not include leakage through feedback resistors.

**Note 4:** Overload recovery time is the time required for the device to recover from saturation when the output has been driven to either rail.

**Note 5:** Specifications are 100% tested at  $T_A = +25^\circ C$ , unless otherwise noted. Limits over temperature are guaranteed by design.

Typical Operating Characteristics

( $V_{CC} = 5V$ ,  $V_{CM} = 0V$ ,  $R_L = 10k\Omega$  connected to  $V_{CC}/2$ ,  $\overline{SHDN} = V_{CC}$ ,  $T_A = +25^\circ C$ , unless otherwise noted.)

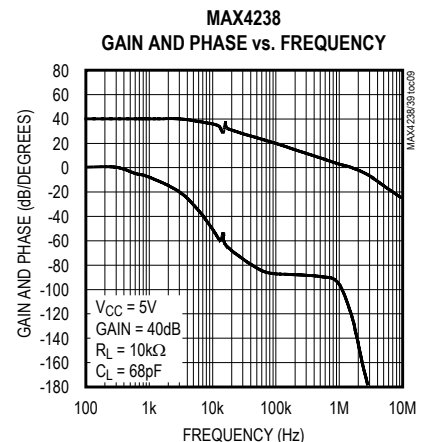
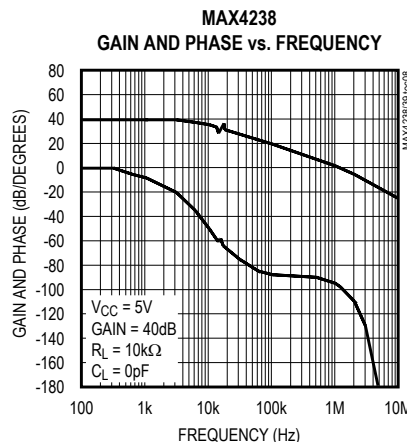
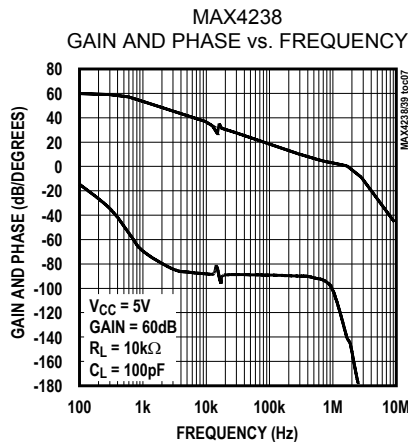
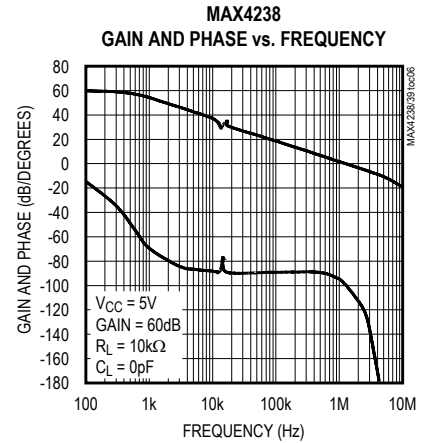
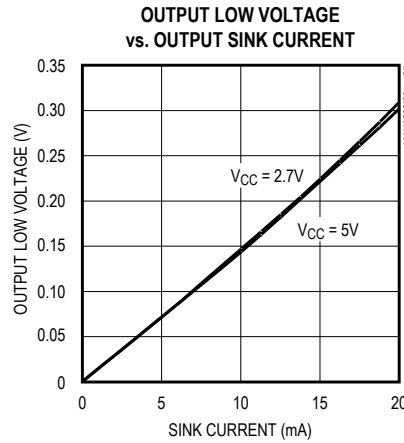
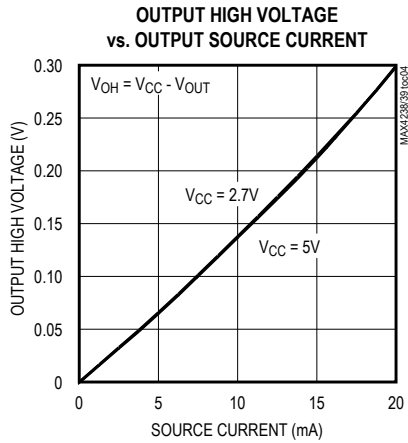
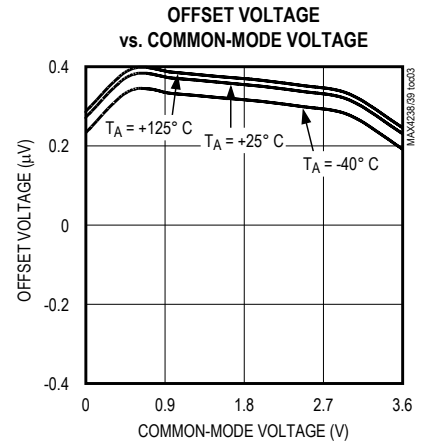
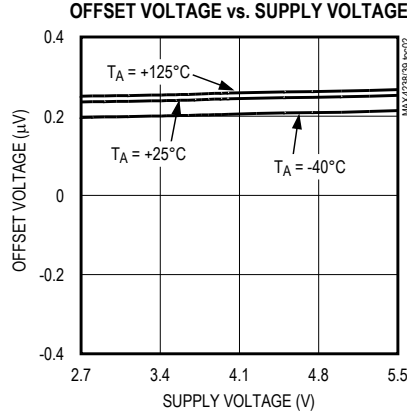
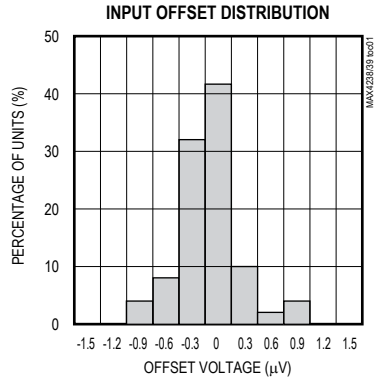

Typical Operating Characteristics (continued)

( $V_{CC} = 5V$ ,  $V_{CM} = 0V$ ,  $R_L = 10k\Omega$  connected to  $V_{CC}/2$ ,  $\overline{SHDN} = V_{CC}$ ,  $T_A = +25^\circ C$ , unless otherwise noted.)

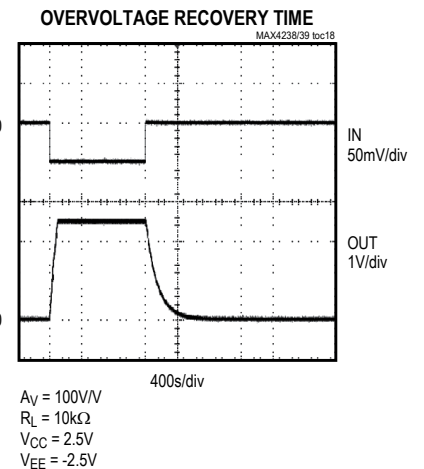
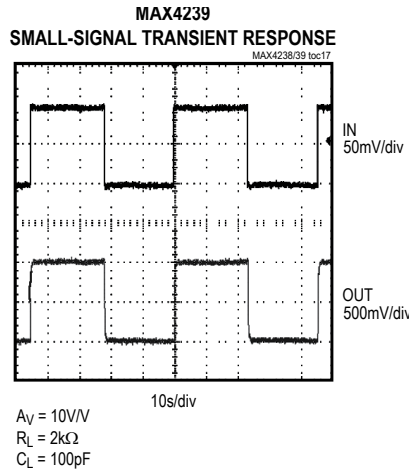
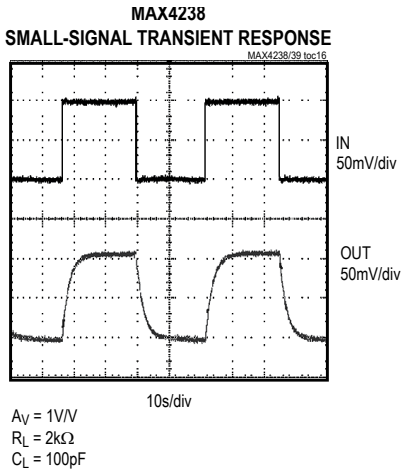
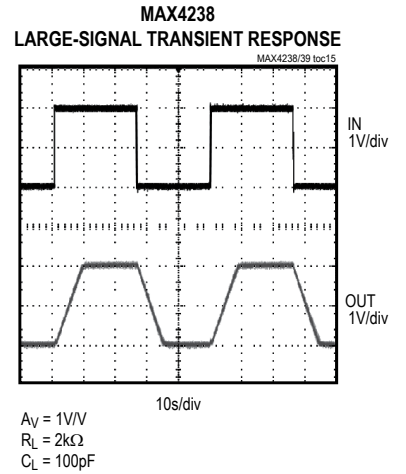
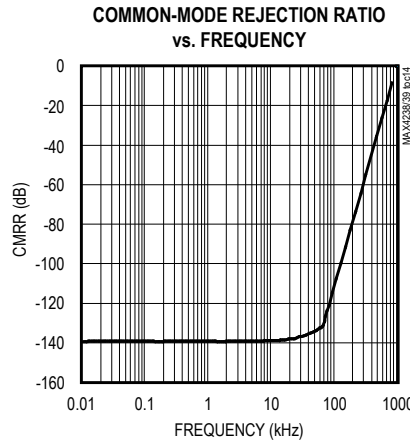
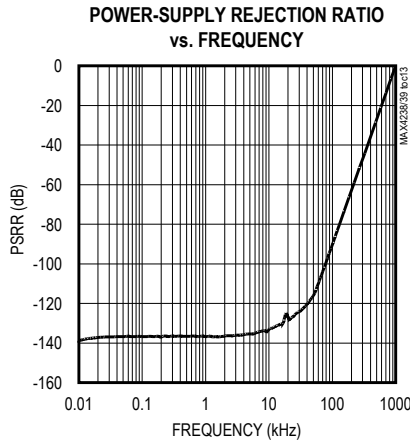
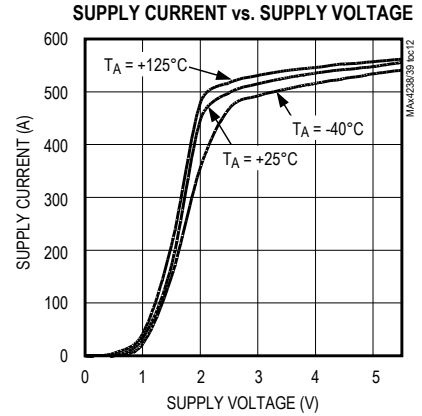
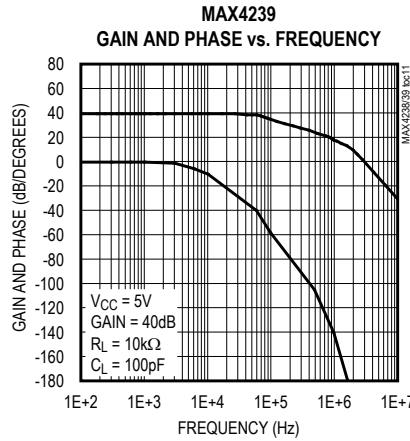
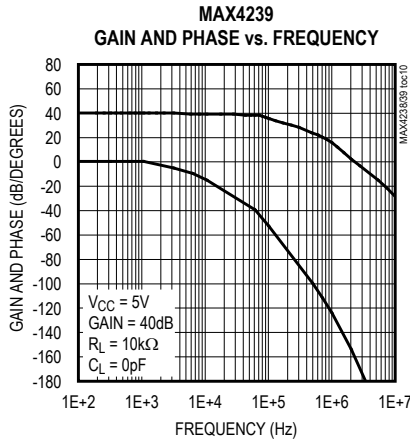

Typical Operating Characteristics (continued)

( $V_{CC} = 5V$ ,  $V_{CM} = 0V$ ,  $R_L = 10k\Omega$  connected to  $V_{CC}/2$ ,  $\overline{SHDN} = V_{CC}$ ,  $T_A = +25^\circ C$ , unless otherwise noted.)

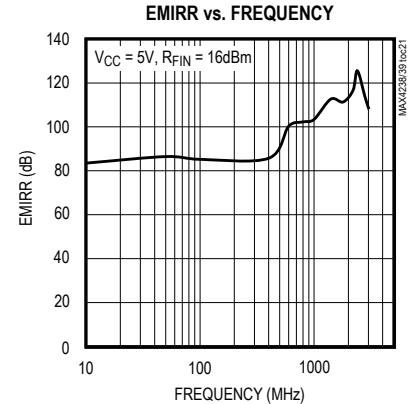
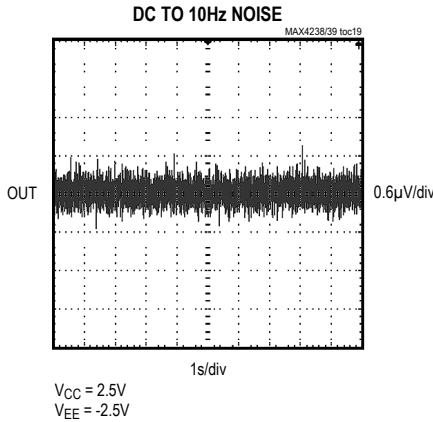

Pin Description

| PIN  |       |      | NAME              | FUNCTION                                                                       |
|------|-------|------|-------------------|--------------------------------------------------------------------------------|
| TDFN | SOT23 | SO   |                   |                                                                                |
| 1    | 1     | 6    | OUT               | Amplifier Output                                                               |
| 2    | 2     | 4    | GND               | Ground                                                                         |
| 3    | 3     | 3    | IN+               | Noninverting Input                                                             |
| 4    | 4     | 2    | IN-               | Inverting Input                                                                |
| 5    | 5     | 1    | $\overline{SHDN}$ | Shutdown Input. Active-low shutdown, connect to $V_{CC}$ for normal operation. |
| 6    | 6     | 7    | $V_{CC}$          | Positive Power Supply                                                          |
| —    | —     | 5, 8 | N.C.              | No Connection. Not internally connected.                                       |
| —    | —     | —    | EP                | Exposed Pad (TDFN only). Connect EP to GND.                                    |

Detailed Description

The MAX4238/MAX4239 are high-precision amplifiers that have less than 2.5µV of input-referred offset and low 1/f noise. These characteristics are achieved through a patented autozeroing technique that samples and cancels the input offset and noise of the amplifier. The pseudorandom clock frequency varies from 10kHz to 15kHz, reducing intermodulation distortion present in chopper-stabilized amplifiers.

Offset Error Sources

To achieve very low offset, several sources of error common to autozero-type amplifiers need to be considered. The first contributor is the settling of the sampling capacitor. This type of error is independent of input-source impedance, or the size of the external gain-setting resistors. Maxim uses a patented design technique to avoid large changes in the voltage on the sampling capacitor to reduce settling time errors.

The second error contributor, which is present in both autozero and chopper-type amplifiers, is the charge injection from the switches. The charge injection appears as current spikes at the input, and combined with the impedance seen at the amplifier’s input, contributes to input offset voltage. Minimize this feedthrough by reducing the size of the gain-setting resistors and the input-source impedance. A capacitor in parallel with the feedback resistor reduces the amount of clock feedthrough to the output by limiting the closed-loop bandwidth of the device.

The design of the MAX4238/MAX4239 minimizes the effects of settling and charge injection to allow specification of an input offset voltage of 0.1µV (typ) and less than 2.5µV over temperature (-40°C to +85°C).

1/f Noise

1/f noise, inherent in all semiconductor devices, is inversely proportional to frequency. 1/f noise increases 3dB/octave and dominates amplifier noise at lower frequencies. This noise appears as a constantly changing voltage in series with any signal being measured. The MAX4238/MAX4239 treat 1/f noise as a slow varying offset error, inherently canceling the 1/f noise.



**Output Overload Recovery**

Autozeroing amplifiers typically require a substantial amount of time to recover from an output overload. This is due to the time it takes for the null amplifier to correct the main amplifier to a valid output. The MAX4238/MAX4239 require only 3.3ms to recover from an output overload (see *Electrical Characteristics* and *Typical Operating Characteristics*).

**Shutdown**

The MAX4238/MAX4239 feature a low-power (0.1µA) shutdown mode. When  $\overline{\text{SHDN}}$  is pulled low, the clock stops and the device output enters a high-impedance state. Connect  $\overline{\text{SHDN}}$  to  $V_{CC}$  for normal operation.

**Applications Information**

**Minimum and Maximum Gain Configurations**

The MAX4238 is a unity-gain stable amplifier with a gain-bandwidth product (GBWP) of 1MHz. The MAX4239 is decompensated for a GBWP of 6.5MHz and is stable with a gain of 10V/V. Unlike conventional operational amplifiers, the MAX4238/MAX4239 have a maximum gain specification. To maintain stability, set the gain of the MAX4238 between  $A_V = 1000V/V$  to  $1V/V$ , and set the gain of the MAX4239 between  $A_V = 6700V/V$  and  $10V/V$ .

**ADC Buffer Amplifier**

The low offset, fast settling time, and 1/f noise cancellation of the MAX4238/MAX4239 make these devices ideal for ADC buffers. The MAX4238/MAX4239 are well suited for low-speed, high-accuracy applications, such as strain gauges (see *Typical Application Circuit*).

**Error Budget Example**

When using the MAX4238/MAX4239 as an ADC buffer, the temperature drift should be taken into account when determining the maximum input signal. With a typical offset drift of  $10nV/^\circ C$ , the drift over a  $10^\circ C$  range is  $100nV$ . Setting this equal to  $1/2\text{LSB}$  in a 16-bit system yields a full-scale range of  $13mV$ . With a single 2.7V supply, an acceptable closed-loop gain is  $A_V = 200$ . This provides sufficient gain while maintaining headroom.

**Pin Configurations**

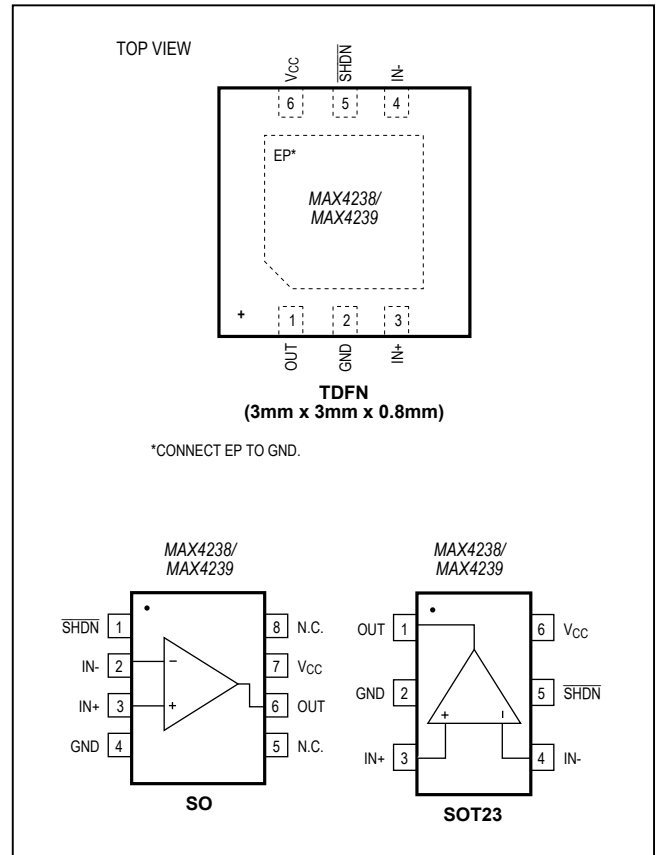

**Chip Information**

PROCESS: BiCMOS

**Package Information**

For the latest package outline information and land patterns (footprints), go to [www.maximintegrated.com/packages](http://www.maximintegrated.com/packages). Note that a "+", "#", or "-" in the package code indicates RoHS status only. Package drawings may show a different suffix character, but the drawing pertains to the package regardless of RoHS status.

| PACKAGE TYPE | PACKAGE CODE | OUTLINE NO.             | LAND PATTERN NO.        |
|--------------|--------------|-------------------------|-------------------------|
| 6 SOT23      | U6F-6        | <a href="#">21-0058</a> | <a href="#">90-0175</a> |
| 8 SO         | S8-4         | <a href="#">21-0041</a> | <a href="#">90-0096</a> |
| 6 TDFN-EP    | T633+2       | <a href="#">21-0137</a> | <a href="#">90-0058</a> |



## Revision History

| REVISION NUMBER | REVISION DATE | DESCRIPTION                                          | PAGES CHANGED |
|-----------------|---------------|------------------------------------------------------|---------------|
| 2               | 5/06          | —                                                    | —             |
| 3               | 8/11          | Added MAX4238 and MAX4239 automotive-qualified parts | 1             |
| 4               | 1/14          | Updated the <i>Typical Operating Characteristics</i> | 7             |
| 5               | 5/15          | Added the <i>Benefits and Features</i> section       | 1             |
| 6               | 9/15          | Deleted duplicate graph and updated scale            | 7             |

For pricing, delivery, and ordering information, please contact Maxim Direct at 1-888-629-4642, or visit Maxim Integrated's website at [www.maximintegrated.com](http://www.maximintegrated.com).

Maxim Integrated cannot assume responsibility for use of any circuitry other than circuitry entirely embodied in a Maxim Integrated product. No circuit patent licenses are implied. Maxim Integrated reserves the right to change the circuitry and specifications without notice at any time. The parametric values (min and max limits) shown in the Electrical Characteristics table are guaranteed. Other parametric values quoted in this data sheet are provided for guidance.