

Description

The IXRFD615X2 is a dual CMOS high-speed, high-current gate driver specifically designed to drive MOSFETs in Push-Pull and Class E Push-Pull HF RF applications as well as other applications requiring ultrafast rise and fall times or short minimum pulse widths. The IXRFD615X2 can source and sink 15 A of peak current per driver while producing voltage rise and fall times of less than 10 ns and minimum pulse widths of 8 ns. The inputs to the driver are compatible with TTL or CMOS and are fully immune to latch up over the entire operating range. Designed with small internal delays, cross conduction or current shoot-through is virtually eliminated. The features and wide safety margin in operating voltage and power make the IXRFD615X2 unmatched in performance and value.

The surface mount IXRFD615X2 is packaged in a low-inductance RF package incorporating advanced layout techniques to minimize stray lead inductances for optimum switching performance. The two drivers are constructed on a single substrate sharing a common ground via the substrate and therefore are not capable of ground isolated operation from each other. An example would be a half-bridge which requires a high-side floating and a ground referenced driver, which is not suitable, as compared to a push-pull configuration in which both drivers are ground referenced, making it a suitable application.

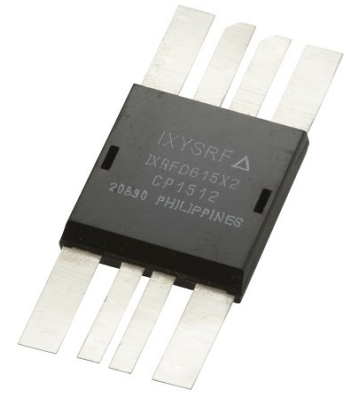

Features

- High Peak Output Current
- Low Output Impedance
- Low Quiescent Supply Current
- Low Propagation Delay
- High Capacitive Load Capability
- Wide Operating Voltage Range

Applications

- RF MOSFET Driver
- Push-Pull RF Generators
- Multi-MHz Switch Mode Supplies
- Pulse Transformer Driver
- Pulse Laser Diode Driver
- Pulse Generator

Fig. 1 Block Diagram and Truth Table per Driver

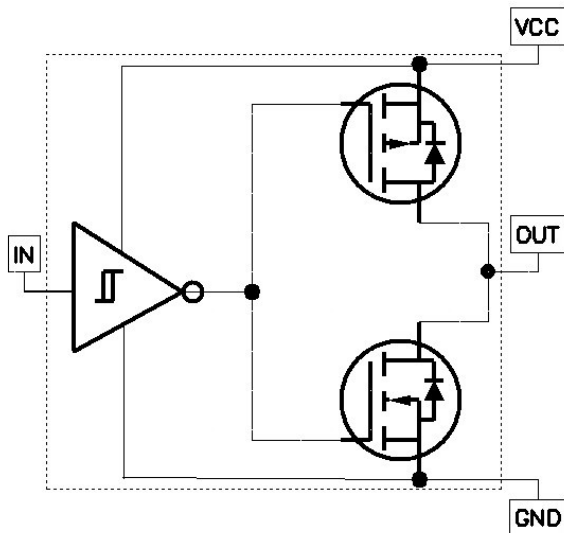

IN	OUT
0	0
1	1

Absolute Maximum Ratings

Parameter	Value
Supply Voltage V_{CC}	30 V
Input Voltage Level V_{IN}	-5 V to $V_{CC} + 0.3$ V
All Other Pins	-0.3 V to $V_{CC} + 0.3$ V
Total Power Dissipation	
T_A (AMBIENT) ≤ 25 C	2 W
T_C (CASE) ≤ 25 C	100 W
Storage Temperature	-40° C to 150° C
Soldering Lead Temperature (10 seconds maximum)	300° C

Parameter	Value
Maximum Junction Temperature	150° C
Operating Temperature Range	-40° C to 85° C
Thermal Impedance (Junction to Case) $R_{\theta JC}$	0.25° C/W

Note: Operating the device outside of the “Absolute Maximum Ratings” may cause permanent damage. Typical values indicate conditions for which the device is intended to be functional but do not guarantee specific performance limits. The guaranteed specifications apply only for the test conditions listed. Exposure to absolute maximum conditions for extended periods may impact device reliability.

Electrical Characteristics

Unless otherwise noted, $T_A = 25^\circ\text{C}$, $8\text{ V} < V_{CC} < 30\text{ V}$.

All voltage measurements with respect to GND. IXRFD615X2 configured as described in *Test Conditions* for one driver.

Symbol	Parameter	Test Conditions	Min	Typ	Max	Units
V_{IH}	High input voltage	$V_{CC} = 15\text{ V}$ for typical value	3.5	3		V
V_{IL}	Low input voltage	$V_{CC} = 15\text{ V}$ for typical value		2.8	0.8	V
V_{HYS}	Input hysteresis			0.23		V
V_{IN}	Input voltage range		-5		$V_{CC} + 0.3$	V
I_{IN}	Input current	$0\text{ V} \leq V_{IN} \leq V_{CC}$	-10		10	μA
V_{OH}	High output voltage		$V_{CC} - 0.025$			V
V_{OL}	Low output voltage				0.025	V
R_{OH}	High output resistance	$V_{CC} = 15\text{ V}$ $I_{OUT} = 100\text{ mA}$		0.5		Ω
R_{OL}	Low output resistance	$V_{CC} = 15\text{ V}$ $I_{OUT} = 100\text{ mA}$		0.35		Ω
I_{PEAK}	Peak output current	$V_{CC} = 15\text{ V}$		14		A
I_{DC}	Continuous output current			1.3		A
t_R	Rise time	$V_{CC} = 15\text{ V}$ $C_L = 1\text{ nF}$ $C_L = 2\text{ nF}$		4 6		ns ns
t_F	Fall time	$V_{CC} = 15\text{ V}$ $C_L = 1\text{ nF}$ $C_L = 2\text{ nF}$		4 5.5		ns ns
t_{ONDLY}	ON propagation delay	$V_{CC} = 15\text{ V}$ $C_L = 2\text{ nF}$		24		ns
t_{OFFDLY}	OFF propagation delay	$V_{CC} = 15\text{ V}$ $C_L = 2\text{ nF}$		22		ns
PW_{min}	Minimum pulse width	FWHM $V_{CC} = 15\text{ V}$ $C_L = 1\text{ nF}$		8		ns
V_{CC}	Power supply voltage	Recommended	8	15	18	V
I_{CC}	Power supply current	$V_{CC} = 15\text{ V}$, $V_{IN} = 0\text{ V}$ $V_{CC} = 15\text{ V}$, $V_{IN} = 3.5\text{ V}$ $V_{CC} = 15\text{ V}$, $V_{IN} = V_{CC}$		0 1 0	1 3 5	mA mA mA

CAUTION: These devices are sensitive to electrostatic discharge; follow proper ESD procedures when handling and assembling.

All specifications are subject to change at any time without notice.

Fig. 2 Output Resistance vs. Supply Voltage

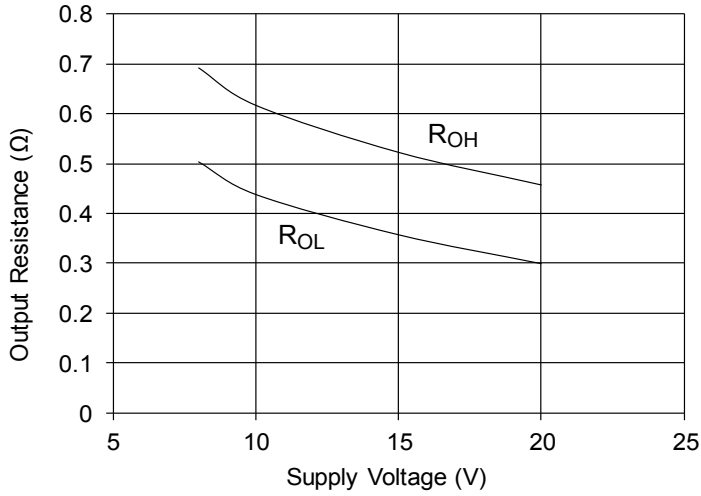

Fig. 3 Input Threshold vs. Supply Voltage

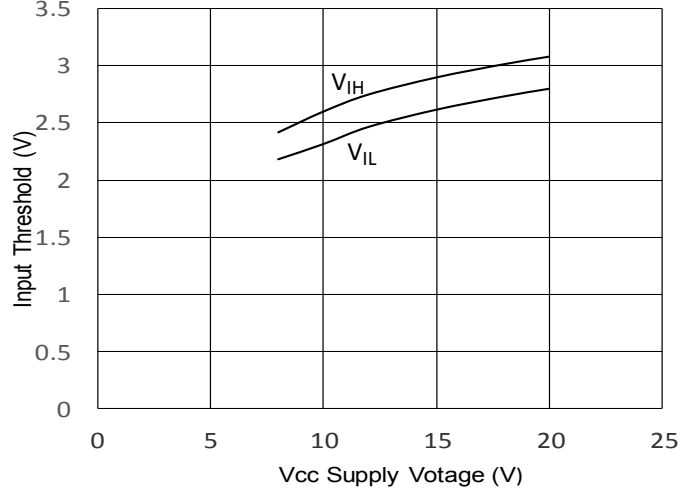

Fig. 4 Rise Time vs. Supply Voltage

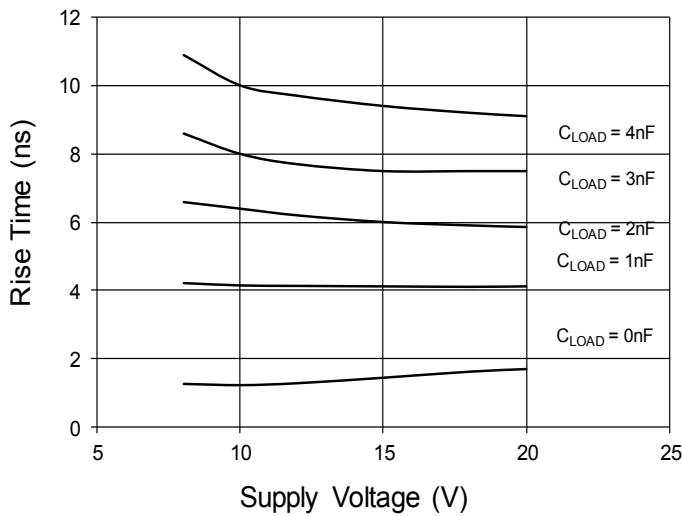

Fig. 5 Fall Time vs. Supply Voltage

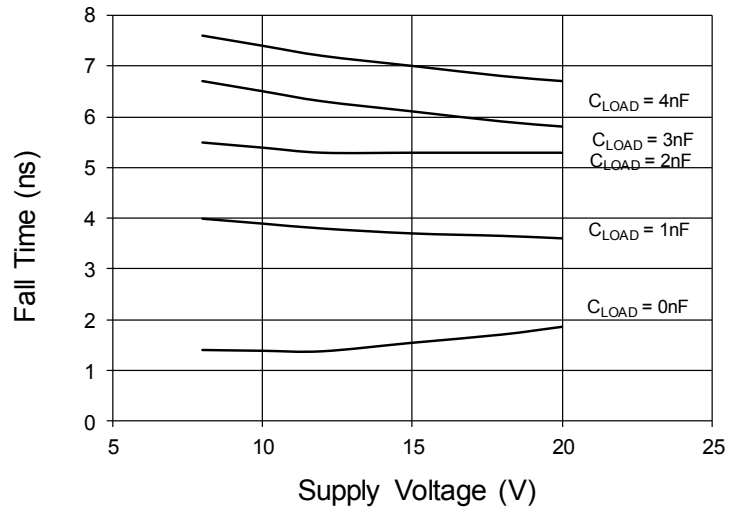

Fig. 6 Propagation Delay vs. Supply Voltage

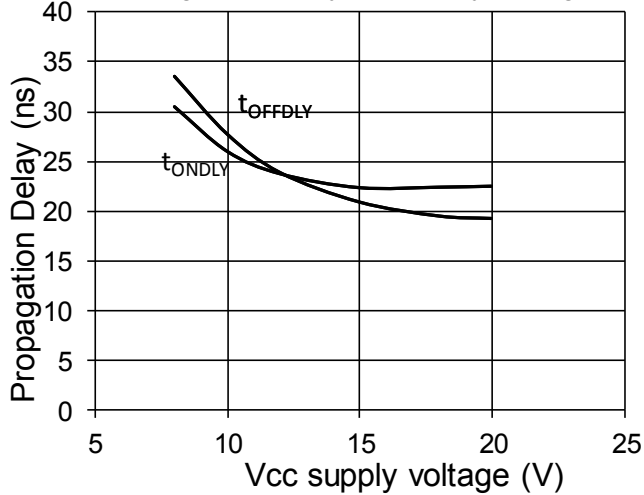

Fig. 7 Quiescent Current vs. Supply Voltage

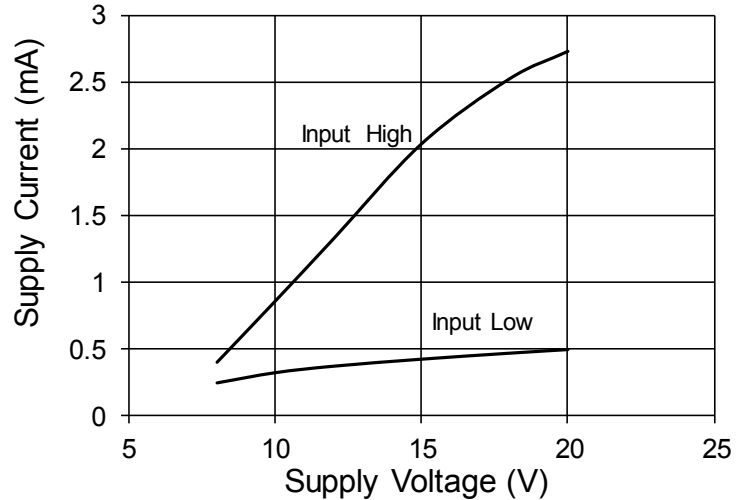

Fig. 8 Supply Current vs. Frequency
V_{CC} = 8 V

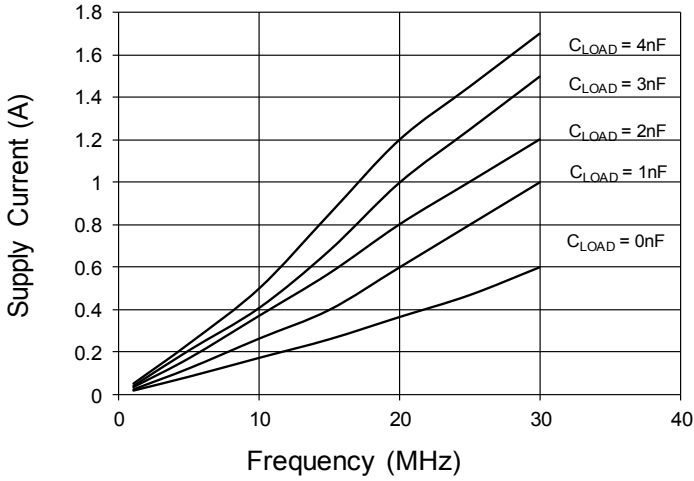

Fig. 9 Supply Current vs. Frequency
V_{CC} = 12 V

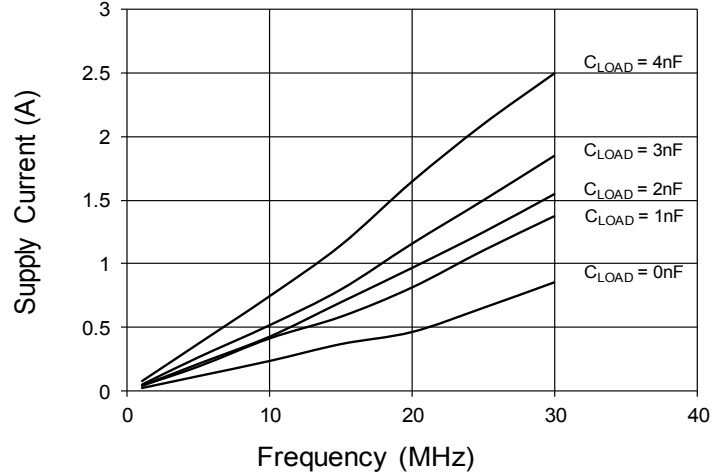

Fig. 10 Supply Current vs. Frequency
V_{CC} = 15 V

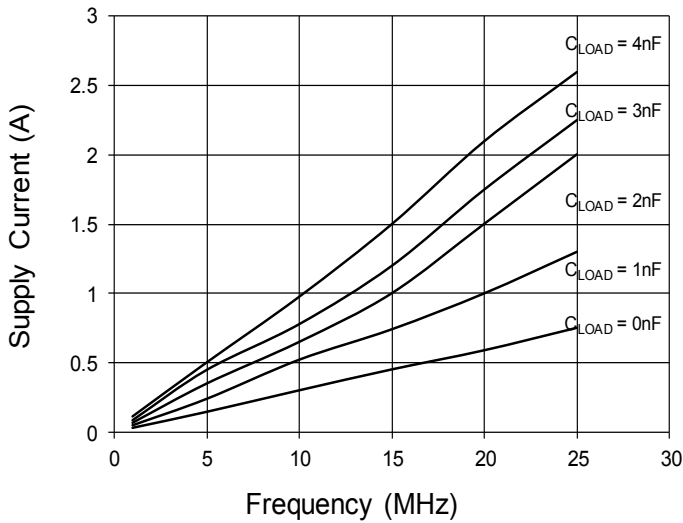

Fig. 11 Supply Current vs. Load Capacitance
V_{CC} = 8 V

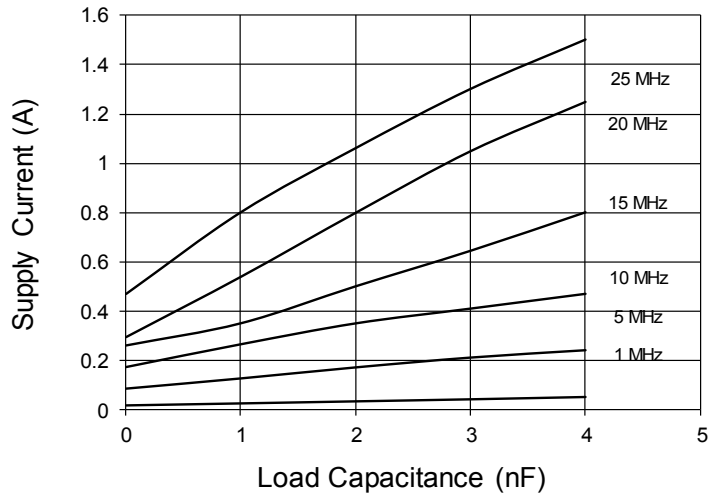

Fig. 12 Supply Current vs. Load Capacitance
V_{CC} = 12 V

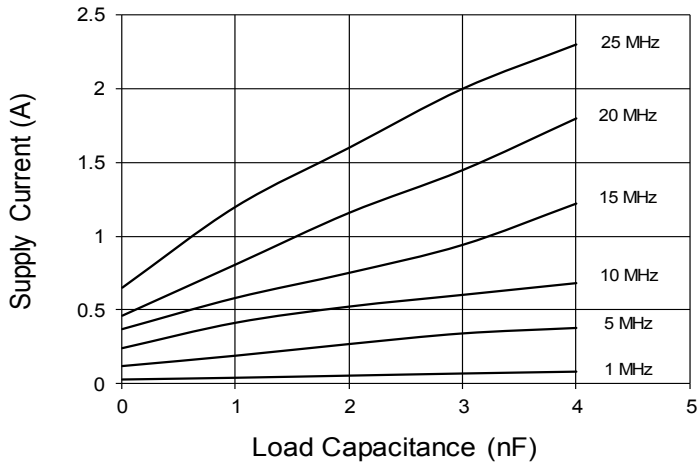

Fig. 13 Supply Current vs. Load Capacitance
V_{CC} = 15 V

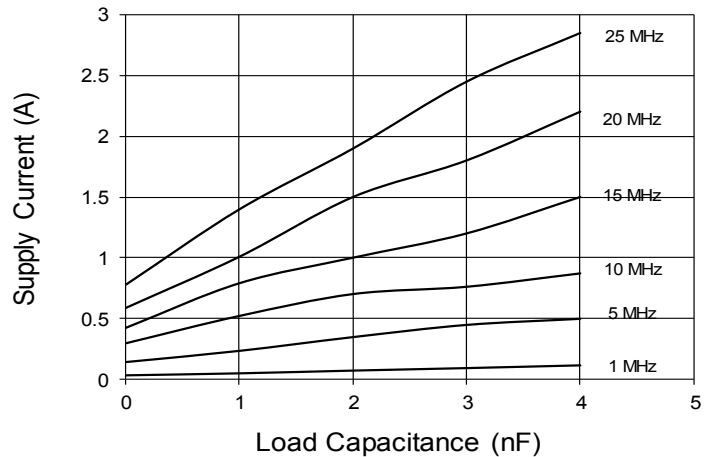

Fig. 14 Peak Source Current vs. Supply Voltage

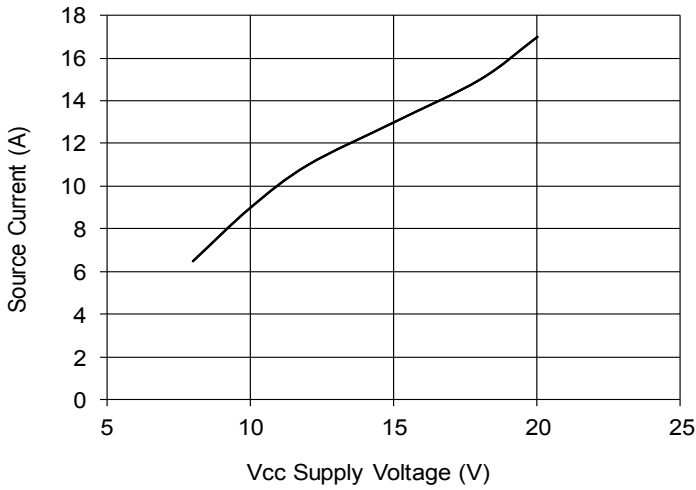

Fig. 15 Peak Sink Current vs. Supply Voltage

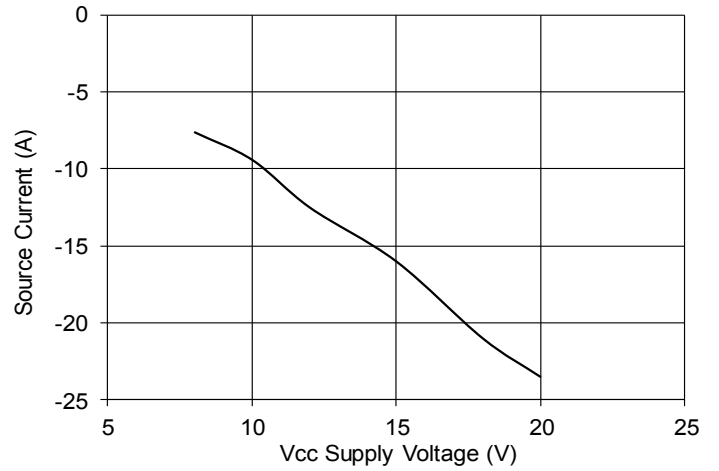

Fig. 16 Peak Source Current vs. Temperature
Vcc = 15 V

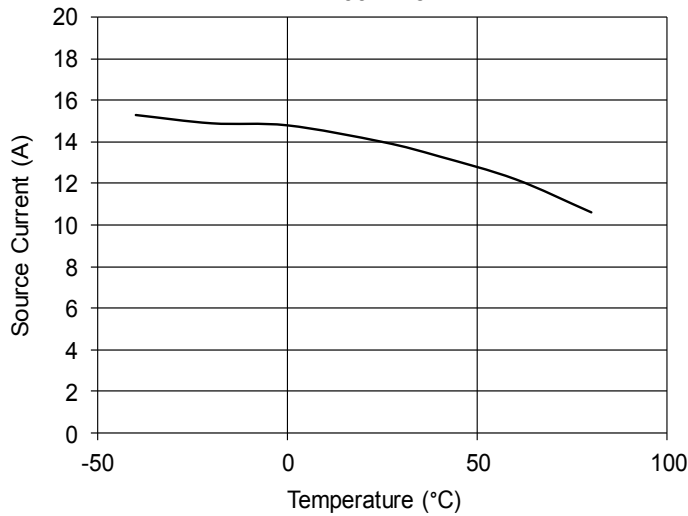

Fig. 17 Peak Sink Current vs. Temperature
Vcc = 15 V

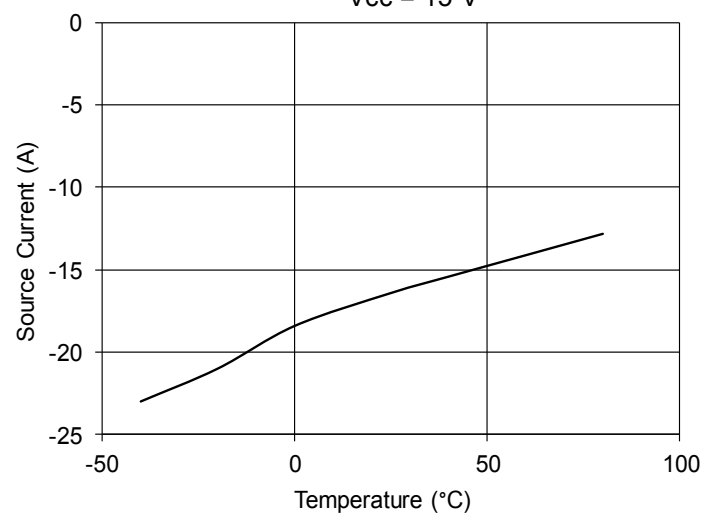

Fig. 18 Rise Time Normalized vs. Temperature
Vcc = 15V

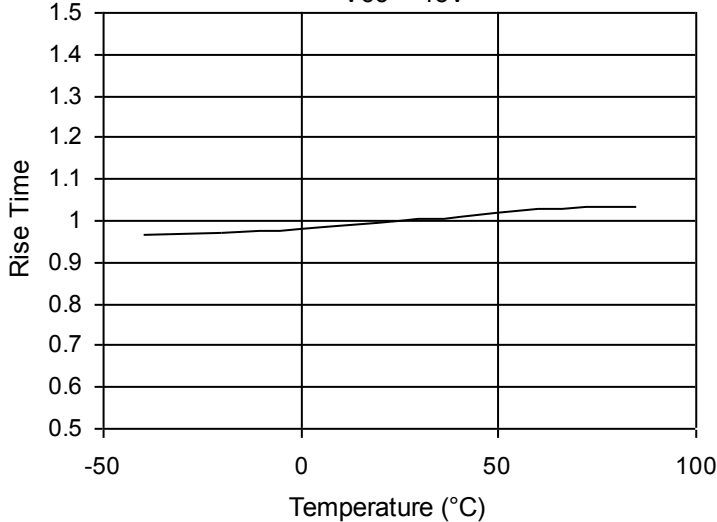

Fig. 19 Fall Time Normalized vs. Temperature
Vcc = 15V

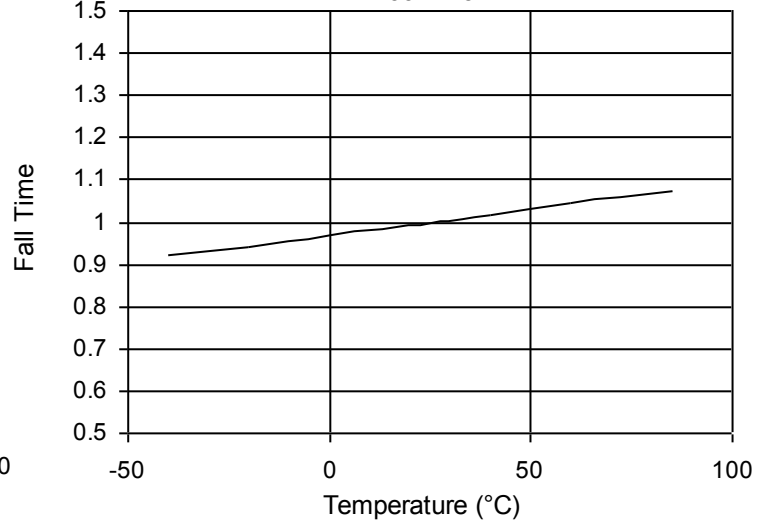

Fig. 20 Pin Description

Symbol	Function	Description
V _{CC}	Supply Voltage	Positive power supply voltage input. These leads provide power to the entire device.
IN	Input	TTL or CMOS compatible.
OUT	Output	Device Output. For application purposes, this lead is connected directly to the Gate of a MOSFET
GND	Power Ground	System ground leads. Internally connected to all circuitry, these leads provide ground reference for the entire device and should be connected to a low-noise analog ground plane for optimum performance.

Fig. 21 Test Circuit Diagram

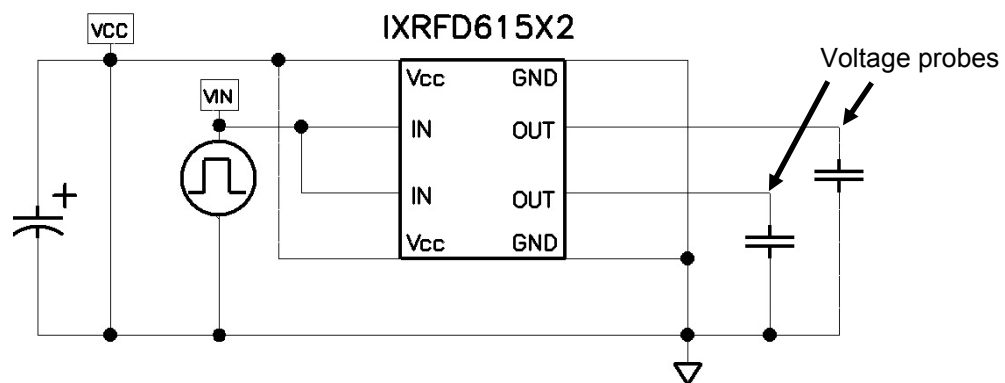

Fig. 22 Timing Diagram

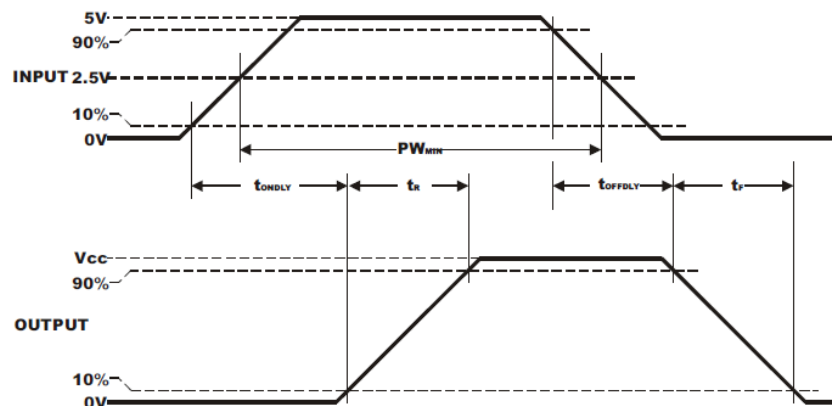
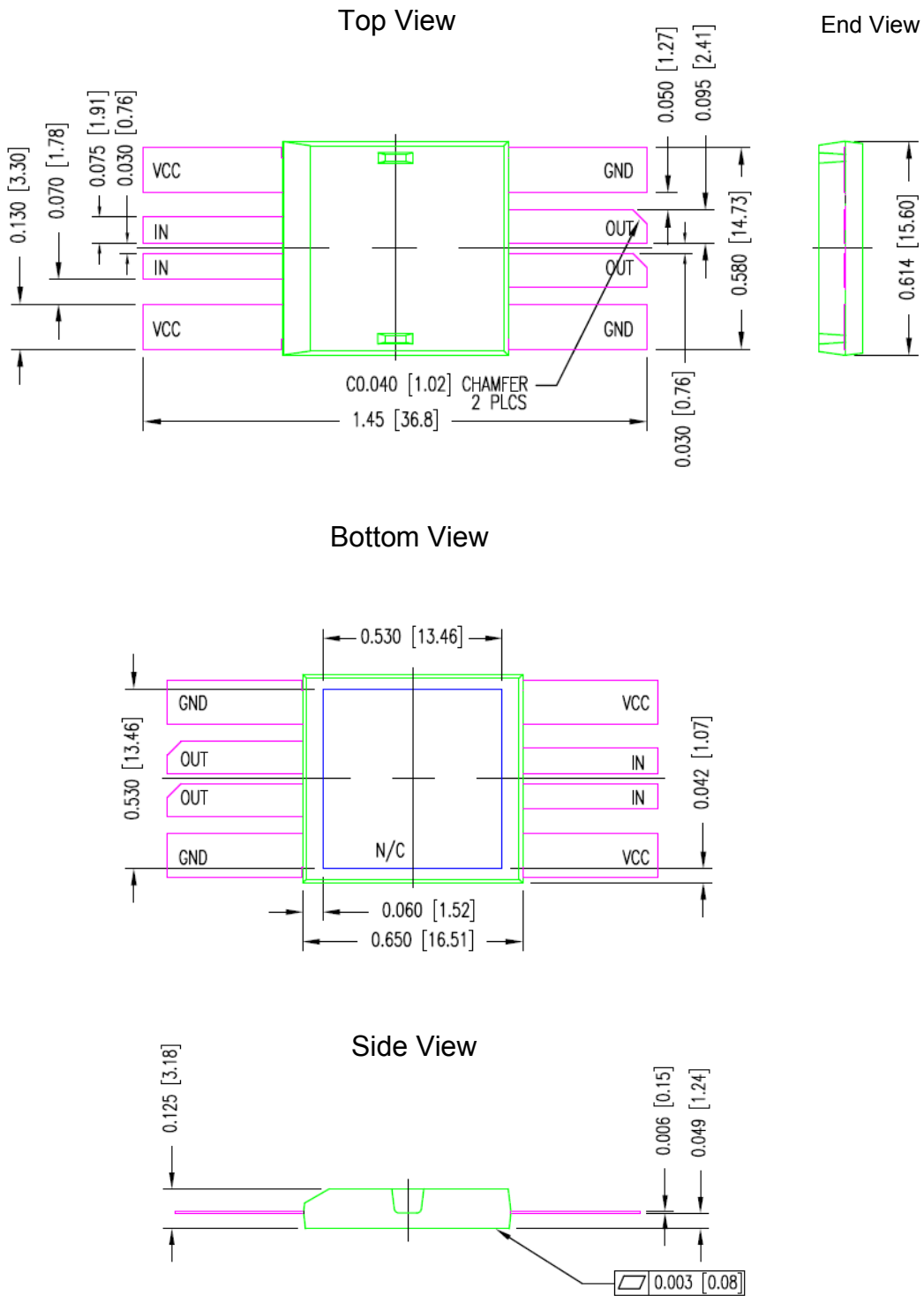

Fig. 23 Package Diagram



DCB – Direct Copper Bond under Nickel plate on an Aluminum Nitride substrate and is electrically isolated from any pin.

Applications Information

Introduction

Circuits capable of very high switching speeds and high frequency operation require close attention to several important issues. Key elements include circuit loop inductance, Vcc bypassing, and grounding.

Circuit Loop Inductance

The power supply to ground current path defines the loop that generates the inductive term. This loop must be kept as short as possible. The output lead must be no further than 0.375 inches (9.5 mm) from the gate of the MOSFET. Furthermore, the output ground leads must provide a balanced symmetric coplanar ground return for optimum operation.

Vcc Bypassing

In order to turn a MOSFET on properly, the IXRFD615X2 must be able to draw up to 15 A of current per driver from the Vcc power supply in 4 to 8 ns (depending upon the input capacitance of the MOSFET being driven). Good performance requires very low impedance between the driver and the power supply. The most common method of achieving this low impedance is to bypass the power supply at the driver with a capacitance value much larger than the load capacitance. Usually, this is achieved by placing two or three different types of bypassing capacitors, with complementary impedance curves, very close to the driver itself. (These capacitors should be carefully selected for low inductance, low resistance, and high pulse current service.) Care should be taken to keep the lengths of the leads between these bypass capacitors and the IXRFD630 to an absolute minimum.

The bypassing should be comprised of several values of MLC (Multi-Layer Ceramic) capacitors symmetrically placed on either side of the IC. Recommended values are 0.01uF and 0.47uF for bypass and at least two 4.7uF tantalums for bulk storage.

Grounding

In order for the design to turn the load off properly, the IXRFD615X2 must be able to drain 15 A of current per driver into an adequate grounding system. There are two paths for returning current that need to be considered: Path one is between the IXRFD615X2 and its load, and path two is between the IXRFD615X2 and its power supply. Both of these paths should be as low in resistance and inductance as possible, and thus as short as practical.

Output Lead Inductance

Of equal importance to supply bypassing and grounding are issues related to the output lead inductance. Every effort should be made to keep the leads between the driver and its load as short and wide as possible, and treated as coplanar transmission lines. In configurations where the optimum configuration of circuit layout and bypassing cannot be used, a series resistance of a few ohms in the gate lead may be necessary to dampen ringing.

Heat Sinking

For high power operation, the bottom side metalized substrate should be placed in compression against an appropriate heat sink. The substrate is metalized for improved heat dissipation, and is not electrically connected to the device or to ground. See the technical note "DE-Series MOSFET and IC Mounting Instructions" on the IXYS Colorado website at www.ixyscolorado.com for detailed mounting instructions.